

General Description

The ESD5Z Series are designed to protect voltage sensitive components from ESD and transient voltage events. Excellent clamping capability, low leakage, and fast response time, make these parts ideal for ESD protection on designs where board space is at a premium.

Applications

- Cellular phones
- Portable devices
- Digital cameras
- Power supplies

Features

- Small Body Outline Dimensions
- Low Body Height
- Stand-off Voltage: 3.3 V – 12.0 V
- Peak Power up to 200 Watts @ 8 x 20 μ s Pulse
- Low Leakage
- Response Time is Typically < 1 ns

Complies with the following standards

IEC61000-4-2

Level 4 15 kV (air discharge)

8 kV(contact discharge)

MIL STD 883E - Method 3015-7 Class 3

25 kV HBM (Human Body Model)

Functional diagram



SOD-523

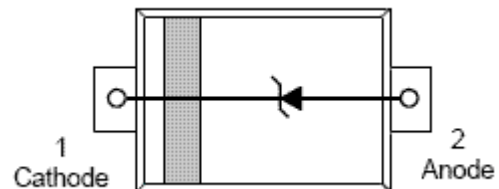

Absolute Ratings (T_{amb}=25°C)

Symbol	Parameter	Value	Units
P _{pp}	Peak Pulse Power (t _p = 8/20 μ s)	200	W
T _L	Maximum lead temperature for soldering during 10s	260	°C
T _{stg}	Storage Temperature Range	-55 to +155	°C
T _{op}	Operating Temperature Range	-40 to +125	°C
T _j	Maximum junction temperature	150	°C
	IEC61000-4-2 (ESD)	air discharge contact discharge	± 15 ± 8 kV
	IEC61000-4-4 (EFT)		40 A
	ESD Voltage	Per Human Body Model Per Machine Model	25 kV 400 V

Electrical Parameter

Symbol	Parameter
I_{PP}	Maximum Reverse Peak Pulse Current
V_C	Clamping Voltage @ I_{PP}
V_{RWM}	Working Peak Reverse Voltage
I_R	Maximum Reverse Leakage Current @ V_{RWM}
I_T	Test Current
V_{BR}	Breakdown Voltage @ I_T
I_F	Forward Current
V_F	Forward Voltage @ I_F

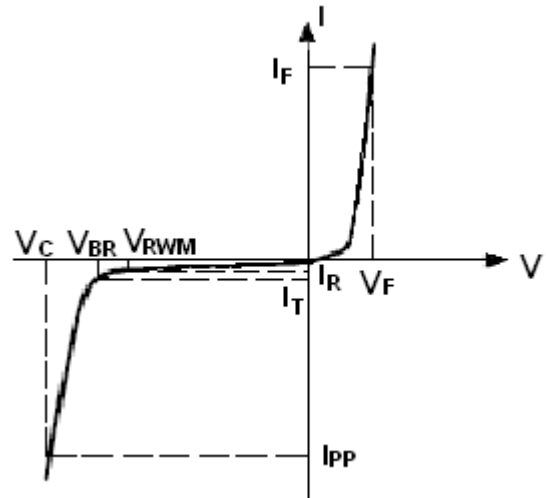

Electrical Characteristics

Ratings at 25°C ambient temperature unless otherwise specified. $V_F = 0.9V$ at $I_F = 10mA$

Part Numbers	V_{BR}			I_T	V_{RWM}	I_R	V_F	I_F	C
	Min.	Typ.	Max.				Max.		Typ. 0v bias
	V	V	V				V		pF
ESD5Z3V3	5.0	6.0	7.0	1	3.0	1	1.25	200	35
ESD5Z5V	6.0	6.6	7.1	1	5.0	1	1.25	200	30
ESD5Z6V	6.8	7.4	7.9	1	6.0	1	1.25	200	30
ESD5Z7V	7.5	8.1	8.6	1	7.0	1	1.25	200	25
ESD5Z12V	13.5	14.2	15.0	1	12.0	1	1.25	200	25

*Surge current waveform per Figure 1.

1. V_{BR} is measured with a pulse test current I_T at an ambient temperature of 25°C.

Typical Characteristics

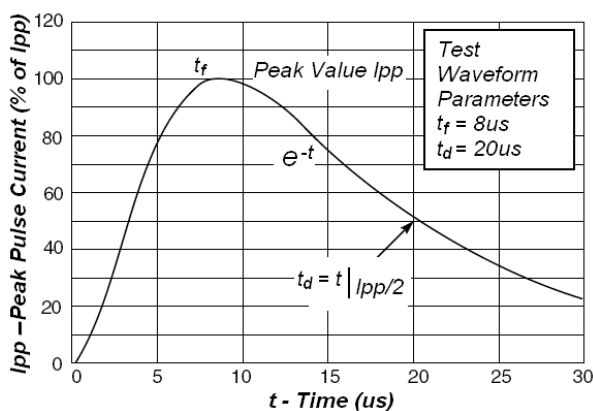

Fig1. Pulse Waveform

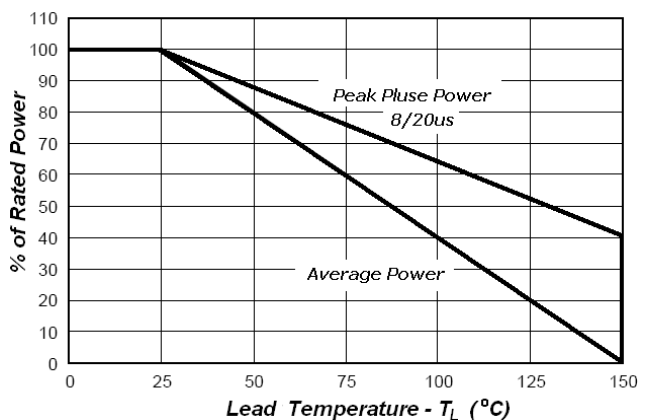

Fig2. Power Derating Curve

Application Note

Electrostatic discharge (ESD) is a major cause of failure in electronic systems. Transient Voltage Suppressors (TVS) are an ideal choice for ESD protection. They are capable of clamping the incoming transient to a low enough level such that damage to the protected semiconductor is prevented.

Surface mount TVS offers the best choice for minimal lead inductance. They serve as parallel protection elements, connected between the signal line to ground. As the transient rises above the operating voltage of the device, the TVS becomes a low impedance path diverting the transient current to ground. The ESD5Z Series is the ideal board level protection of ESD sensitive semiconductor components.

The tiny SOD-523 package allows design flexibility in the design of high density boards where the space saving is at a premium. This enables to shorten the routing and contributes to hardening against ESD.

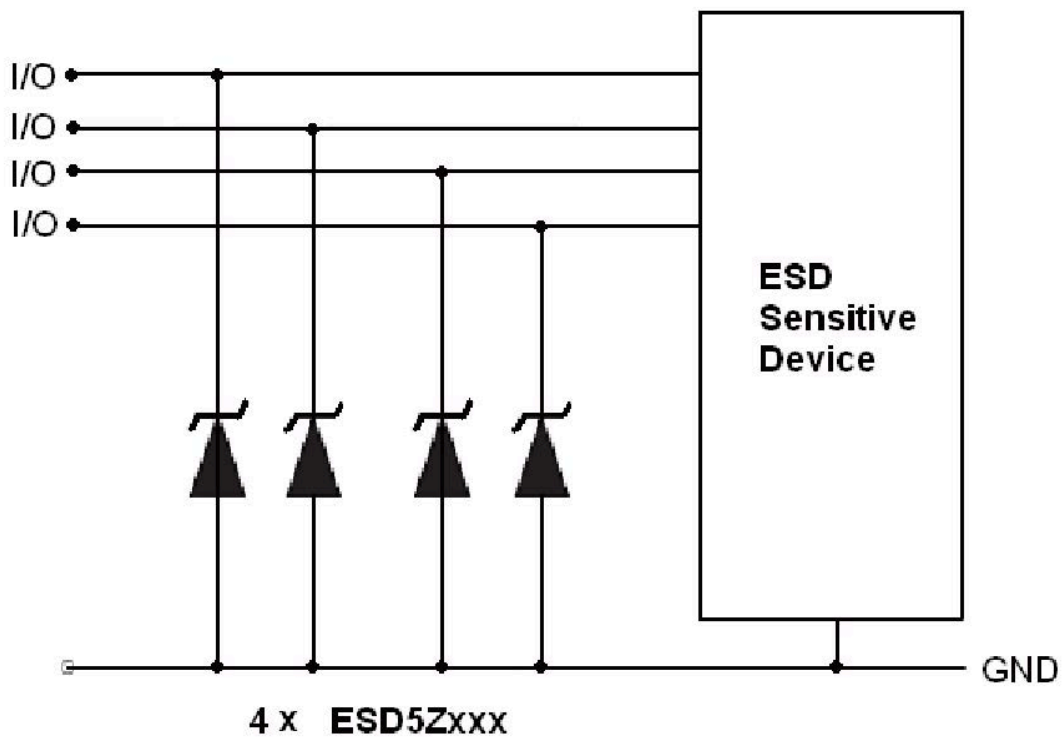

SOD-523 Mechanical Data

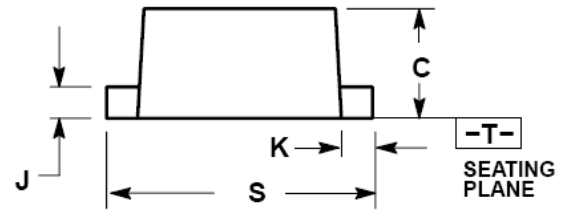
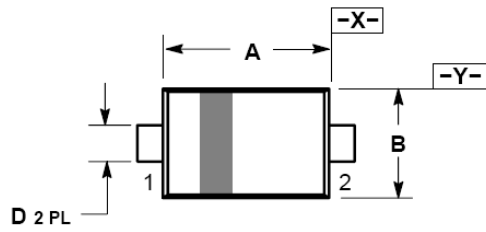

D 2 PL
 \oplus 0.08 (0.003) M T X Y

Dim	Millimeters			INCHES		
	MIN	NOM	MAX	MIN	NOM	MAX
A	1.10	1.20	1.30	0.043	0.047	0.051
B	0.70	0.80	0.90	0.028	0.032	0.035
C	0.50	0.60	0.70	0.020	0.024	0.028
D	0.25	0.30	0.35	0.010	0.012	0.014
J	0.07	0.14	0.20	0.0028	0.0055	0.0079
K	0.15	0.20	0.25	0.006	0.008	0.010
S	1.50	1.60	1.70	0.059	0.063	0.067